

2020-01-15

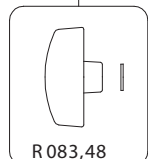
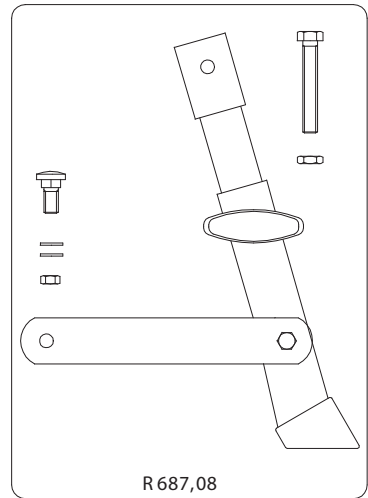
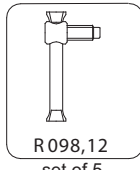
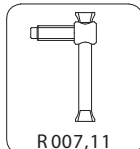
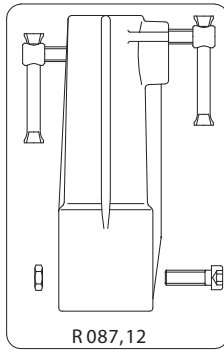
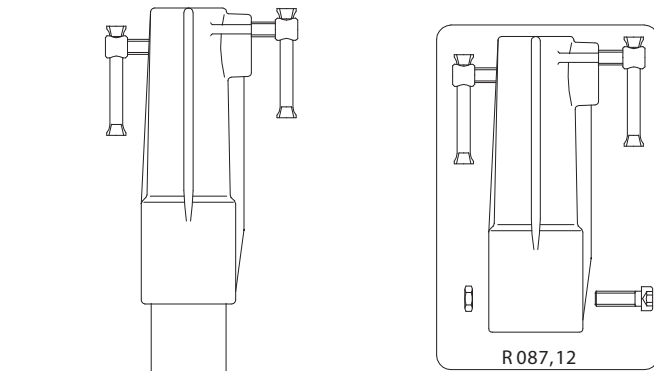

FOR 3rd SCT
SPARE LIST
SEE DRAWING:
ART.
R687,04

FOR GEARED COLUMN
SPARE LIST
SEE DRAWING:
ART.
R687,91

FOR CRANKCASE
SPARE LIST
SEE DRAWING:
ART.
R083,72

